



ISO 9001 國際品質認證
ISO 9001 CERTIFICATE

松暉電機工業股份有限公司
SONG HUEI ELECTRIC CO., LTD.
佛山市松暉電機科技有限公司
FOSHAN SONG HUEI ELECTRIC CO., LTD.

一般事項 General	
使用溫度範圍 Operating temperature	-10 °C ~ 70 °C
儲存溫度 Storage temperature	-40 °C ~ 85 °C
電氣特性 Electrical Characteristics	
額定功率 Power rating	DC 5 V 0.5 mA
絕緣阻抗 Insulation resistance	More than 10 MΩ at DC 50 V 1 minute
耐電壓 Withstand voltage	1 Minute at AC 50 V
滑動雜訊 Sliding noise	<p>t1, t3 ≤ 3 mS, t2 ≤ 2 mS (Test conditions 測試條件: 360° / S) Using the C / R filter circuit is recommended 建議使用 C / R 濾波電路</p>
分解能力 Resolution	<input type="checkbox"/> 12 <input type="checkbox"/> 24 個相位脈衝 / 360° <input type="checkbox"/> 12 <input type="checkbox"/> 24 pulses / 360° for each phase.
相位差 Phase difference	$\Delta T = 0.25 \pm 0.17 T$
輸出信號和旋轉方向 Output signal and rotational direction	<p>順時針方向 A Signal OFF ON</p> <p>C.W direction B Signal OFF ON</p>
機械特性 Mechanical Characteristics	
全回轉角度 Total rotational angle	360°
全回力矩 Rotational torque	20 ~ 200 gf.cm (Shaft may be hard rotatable at -10 °C ~ +5 °C 但在 -10 °C ~ +5 °C 軸勉強可轉動)
軸推拉力矩 Shaft push-pull strength	<input type="checkbox"/> With switch 5 Kgf <input type="checkbox"/> without switch 8 Kgf <input type="checkbox"/> 帶開關為 5 Kgf <input type="checkbox"/> 不帶開關為 8 Kgf
定位點數及位置 Number and position detent	<input type="checkbox"/> 12 detents (Stepangle: 30° ± 3°) <input type="checkbox"/> 24 detents (Stepangle: 15° ± 3°) <input type="checkbox"/> 0 detents (Step angle: 360°)
軸向間隙 Shaft play in axial direction	0.4 mm max
軸擺動 Shaft wobble	0.7 * L / 30 mm p-p 以下 (L: 指安裝平面到軸的柄端的距離) 0.7 * L / 30 mm p-p Max L: Distance between mounting surface and the top of the shaft.
軸的回轉方向擺動 Shaft play in rotational wobble	5° 以下 5° Max
回轉壽命 Rotational life	30,000 cycles at a speed of 600 cycles / per hour 每小時 600 圈的速度測試



ISO 9001 國際品質認證
ISO 9001 CERTIFICATE

松 暉 電 機 工 業 股 份 有 限 公 司
SONG HUEI ELECTRIC CO., LTD.
佛 山 市 松 暉 電 機 科 技 有 限 公 司
FOSHAN SONG HUEI ELECTRIC CO., LTD.

焊錫耐熱性 Resistance to soldering heat	手焊: 300 °C 以下, 3 秒以內. 自動或半自動機台焊錫條件: 預熱:基板表面溫度 100 °C 以下, 時間 1分以內, 過錫爐: 260 ± 5 °C 3 ~ 5 秒 Manual soldering: less than 300 °C and within 3 seconds. For automated or semi-automated soldering equipments: Preheating: surface temperature of board: less than 100 °C and within 1 min. Auto soldering: 260 ± 5 °C for 3 ~ 5 seconds.
推動開關規格 Push-on Switch Specific Ations	
開關電路 Switch circuit	Single pole and single throw (push on) 單極單投 (推動)
開關工作行程 Switch travel (mm)	0.5 ^{+0.4} _{-0.3} mm
開關作動力 Switch operating force	500 ⁺²⁰⁰ ₋₂₀₀ gf.cm
開關額定功率 Switch rating power	DC 5 V 10 mA
開關接觸阻抗 Switch contact resistance	第一個週期: 100 mΩ, 在有效的壽命範圍結束後 200 mΩ First period 100 mΩ ; 200 mΩ after the end of useful life is reached
開關按壓壽命 Switch push life	20,000 cycles min. The encoder shall be rotated 20,000 cycles at a speed of 600 cycles / H without electrical load. The measurement is done at each 5,000 cycles (shaft push load: 1 kgf). 在無負荷條件下,對軸以下每小時 600 周往反速度連續運轉 20.000 往返,在 5,000 次往返時進行中間測定 (軸按壓力 1 kg 以下)。
Note 注明: 當產品無帶開關結構時, 以上推動開關規格整項取消 Note: When product without switch structure, the above switch specifications are cancelled.	

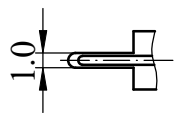
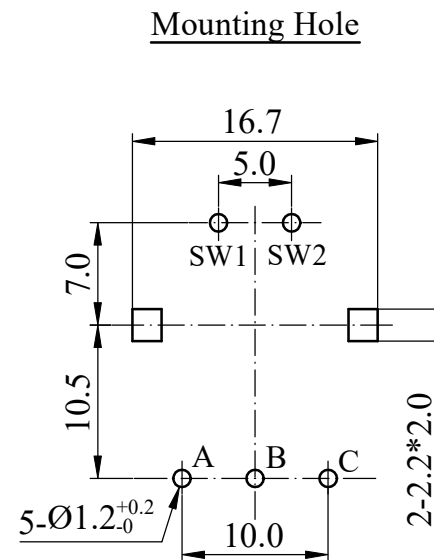
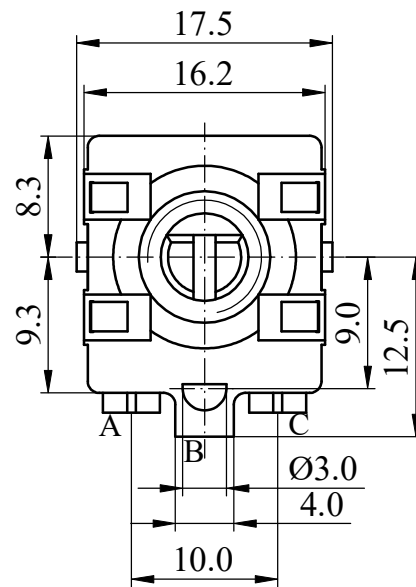
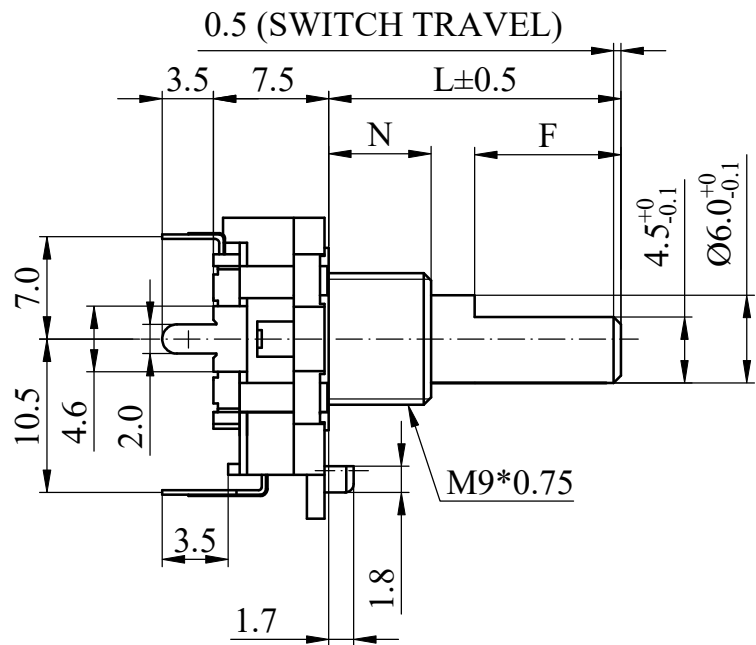

CIRCUIT

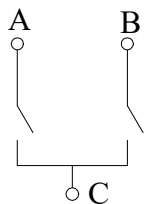

SWITCH

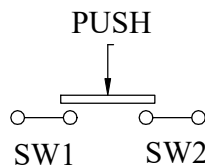

\triangle/\triangle	N=	<input type="checkbox"/> 5	<input type="checkbox"/> 7	Non notation tolerance	
	L=	15	20	25	< 10 ±0.3
	F=	7	12	12	10 ~ 100 ±0.5
	choose				> 100 ±0.8



SONG HUEI ELECTRIC CO., LTD.
FOSHAN SONG HUEI ELECTRIC CO., LTD.

MODEL: ED1612S(F)/PH/0496

\triangle/\triangle	取消L=30	何鸿根	2025.03.12
\triangle/\triangle	增加N=5	何鸿根	2021.04.28
\triangle/\triangle	整理图元	何鸿根	2019.01.05
\triangle/\triangle	取消N=5	何鸿根	2018.09.06

Approval



Checked



Drawn



UNIT

mm

SCALE

2:1

VERSION

1.4

DATE

2017.07.31

DRAWING NO.

ED-073

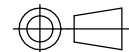

ISSUE

SUBJECT

NAME

DATE

RECORD

Shaft Types 軸型:

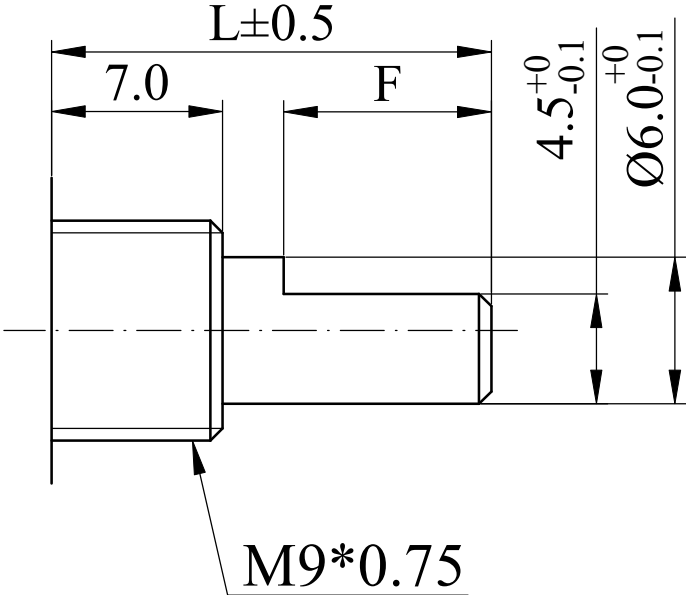

F Type

L=	15	20	25
F=	7	12	12

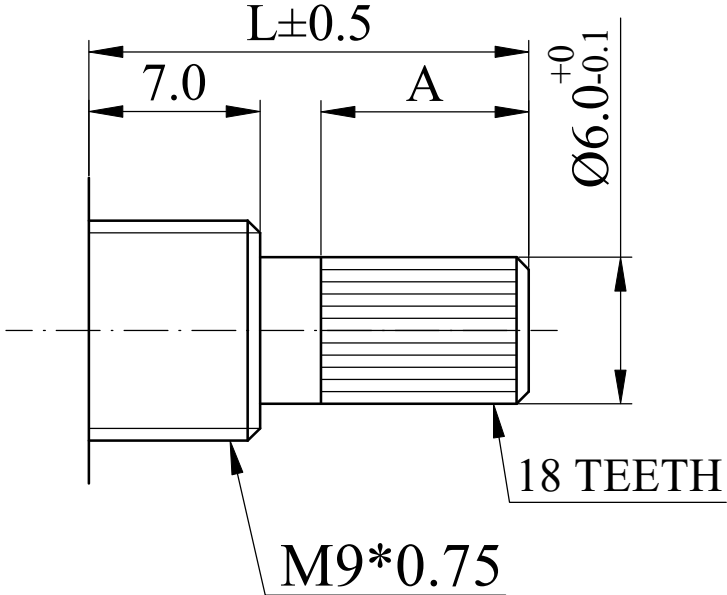

KC Type

L=	15	20	25
F=	7	12	12